

**OWNER'S/
OPERATOR'S
MANUAL**

**MODEL NO.
ATVK-400**

⚠ CAUTION

For Safe Operation
Read Rules And
Instructions Carefully

SINO LEEINGLES, PIDA AYUDA
A AIGUIEN QUE SI LO LEA
PARA QUE LE TRADUZCA LAS
MEDIDAS DE SEGURIDAD.



**STATEMENT
OF POLICY**

It is the policy of Worksaver, Inc. to improve its products where it is possible and practical to do so. Worksaver, Inc. reserves the right to make changes or improvements in design and construction at any time, without incurring the obligation to make these changes on previously manufactured units.

**ATV
Broadcast Seeder - Spreader**

**Safety Instructions
Tractor Preparation
Operating Instructions**

**Assembly & Mounting
Maintenance
Repair Parts**

⚠ ATTENTION! SAFETY RULES

- 1. Read instruction manual and make sure all operators are knowledgeable on correct operation of equipment and familiar with the Safety Rules of Operation.**
- 2. Never allow riders on equipment.**
- 3. When operating on rough or uneven terrain, use extreme caution and a safe operating speed.**
- 4. When spreading seed or fertilizer, always use safety goggles.**
- 5. Never operate equipment when anyone is within 50 feet of seeder/spreader.**

Before operating equipment – If you have any questions regarding the proper assembly or operation, contact your dealer or representative.

To the Owner/Operator/Dealer

All implements with moving parts are potentially hazardous. There is no substitute for a cautious, safe-minded operator who recognizes the potential hazards and follows reasonable safety practices. The manufacturer has designed this implement to be used with all its safety equipment properly attached to minimize the chance of accidents.

BEFORE YOU START!!

Read the safety messages on the implement and shown in your manual.
Observe the rules of safety and common sense!



THIS SYMBOL MEANS

- ATTENTION!
- BECOME ALERT!
- YOUR SAFETY IS INVOLVED!

THIS SAFETY ALERT SYMBOL IDENTIFIES IMPORTANT SAFETY WARNING MESSAGES. CAREFULLY READ EACH WARNING MESSAGE THAT FOLLOWS. FAILURE TO UNDERSTAND AND OBEY A SAFETY WARNING, OR RECOGNIZE A SAFETY HAZARD, COULD RESULT IN AN INJURY OR DEATH TO YOU OR OTHERS AROUND YOU. THE OPERATOR IS ULTIMATELY RESPONSIBLE FOR THE SAFETY OF HIMSELF, AS WELL AS OTHERS, IN THE OPERATING AREA OF THE ATV AND EQUIPMENT.

UNDERSTAND SIGNAL WORDS

Note the use of the signal words **DANGER**, **WARNING** and **CAUTION** with the safety messages. The appropriate signal word for each has been selected using the following guidelines:

DANGER: Indicates an imminently hazardous situation that, if not avoided, will result in death or serious injury. This signal word is to be limited to the most extreme situations typically for machine components which, for functional purposes, cannot be guarded.

WARNING: Indicates a potentially hazardous situation that, if not avoided, could result in death or serious injury, and includes hazards that are exposed when guards are removed. It may also be used to alert against unsafe practices.

CAUTION: Indicates a potentially hazardous situation that, if not avoided, may result in minor or moderate injury. It may also be used to alert against unsafe practices.

IMPORTANT SAFETY INFORMATION!

Working with unfamiliar equipment can lead to careless injuries. Read this manual, and the manual for your ATV, before assembly or operating, to acquaint yourself with the machine. It is the equipment owner's responsibility, if this equipment is used by any person other than yourself, is loaned or rented, to make certain that the operator, prior to operating:

1. Reads and understands the operator's manuals.
2. Is instructed in safe and proper use.



The use of this equipment is subject to certain hazards which cannot be protected against by mechanical means or product design. All operators of this equipment must read and understand this entire manual, paying particular attention to safety and operating instructions, prior to using. If there is something in this manual you do not understand, ask your supervisor, or your dealer, to explain it to you.



Most accidents occur because of neglect or carelessness. Keep all helpers and bystanders fifty feet (50') from operating equipment. Only properly trained people should operate this ATV and attached implement. Always stop the ATV, set brake, shut off the engine and remove the key before dismounting. Never leave equipment unattended with the engine running.

SAFETY INFORMATION (continued)



All equipment is potentially hazardous. There is no substitute for a cautious, safe-minded operator who recognizes potential hazards and follows reasonable safety practices.



When the use of hand tools is required to perform any part of assembly, installation, adjustment, maintaining, repairing, removal, or moving the implement, be sure the tools used are designed and recommended by the tool manufacturer for that specific task.



Personal protection equipment including safety glasses, safety shoes, and gloves are recommended during assembly, installation, operation, adjustment, maintaining, repairing, removal, or moving of the spreader.



Always use two people to handle heavy, unwieldy components during assembly, installation, removal, or moving of the implement.



Never place any part of your body where it would be in danger if movement should occur during assembly, installation, operation, maintaining, repairing, removal, or moving the implement.



A heavy load can cause instability of the vehicle. Use extreme care during travel. Slow down on turns and watch out for bumps. The vehicle may need front counter-weights to counter-balance the weight of the implement. An unstable vehicle could steer badly and possibly tip over, causing injury or death.



Never use alcoholic beverages or drugs which can hinder alertness or coordination while operating equipment. Consult your doctor about operating tractor and implement while taking prescription medications.



Do not allow others to ride on the ATV with an operator. Riders are subject to injury such as being struck by foreign objects or being thrown off. Riders obstruct the operator's view resulting in unsafe operation. **Never allow anyone to ride on the ATV or seeder mount!**



Before you operate any implement, check over all pins, bolts and connections to be sure all are securely in place. Replace any damaged or worn parts immediately.



Do not allow anyone who is not familiar with the safety rules and operation instructions to use this equipment.



Never allow children to operate or be around equipment.



Keep alert and watch the front as well as the rear when working with the attached implements.













When maneuvering close to buildings or passing through narrow areas, be sure to allow sufficient clearance for the implement.



Do not operate close to ditches or creeks. Slow down when operating over rough ground.

SAFETY INFORMATION (continued)

-  Never operate broadcast spreader if anyone is within 50 ft. of ATV and spreader.
-  Never use your hand or fingers to clear a jam of material in the feed gate. Use a clean stick or rod.
-  When spreading any material, always use safety goggles or safety glasses with side shields.
-  When spreading, always be aware of the wind direction and that it may carry the material further than normal spread width.
-  Use care when working on slopes.
-  Do not allow tools to cause sparks when working on a battery. **BATTERIES PRODUCE EXPLOSIVE HYDROGEN GAS.** A spark could cause an explosion if hydrogen gas is present.
-  Observe correct polarity (+ and –) on batteries.
-  Disconnect negative (–) cable first and connect it last.
-  Avoid excessive speed during operation. Use lower gear to slow forward travel.
-  Always shut off ATV and shift to “Park” or set brakes when leaving tractor. Remove key when leaving ATV unattended.
-  Before operating equipment: if you have any questions regarding the proper assembly or operation, contact your dealer or representative.

SAFETY SIGNS



This SAFETY SIGN is located on the seeder.

NOTE:
If Safety Sign is missing or damaged,
replace immediately.



This SAFETY SIGN is located
on the mounting frame.

INSTRUCTIONS

VEHICLE PREPARATION

The 12 volt electric seeder can be mounted on most all terrain vehicles (ATV).

The ATV must have a 12 volt electrical system or you need to supply a separate 12 volt battery to power the spreader fan motor.

Be sure tires and rims are in good condition. Inflate tires to the proper recommended air pressure.

⚠ CAUTION! ⚠

Be sure your vehicle is in good condition and properly equipped with counterweights if required. Read all the safety precautions and make sure all vehicle operators are familiar with the safety rules of vehicle operation.

PACKING

Most ATV Broadcast Seeder-Spreaders are packaged partially assembled in one carton consisting of: a basic seeder unit, a scale plate with rod assembly, mounting frame parts and a mounting frame hardware kit.

ASSEMBLY & MOUNTING

Mounting Bracket – Look at the “exploded” view of the mounting bracket parts and hardware. The height of the cross tube allows the seeder to be mounted at a height that fits your ATV. Make sure the seeder control lever is clear of the rear cross tube of your ATV rack.

Assemble the parts as shown in the drawing. We suggest keeping all bolts loose until all bolts are in place – then tighten all clamps and bolts securely.

Seeder Mounting – Slide the seeder/spreader unit down over the up-right on the lower mounting bracket and line up holes. Insert the 1/4" x 2" hex head bolt and fasten the two together securely.

Bolt the scale plate and control rod assembly on the front left hand corner of the main seeder frame. Two round head 1/4" – 20 x 1/2 bolts are provided in the hardware package for this. Place the end of the control rod through the hole in the end of the seed gate control plate (middle plate) and secure with the 3/32" x 1/2" cotter pin provided.

NOTE: If the paint on the control rod does not allow the button to slide on the control rod, it may be necessary to sand some of the paint off with emery paper.

With the seed gate (middle plate) in the closed position, place the scale plate lever in the closed position. Retighten the adjustment bolt so that the adjustment button is tight on the control rod.

Move the lever and check to see that the seed gate (middle plate) is moving with the lever.

Place the lever at the desired setting on the scale plate and locate the stop bolt so that each time the lever is pulled to the open position it will be at the same position. Tighten the stop bolt.

WIRING

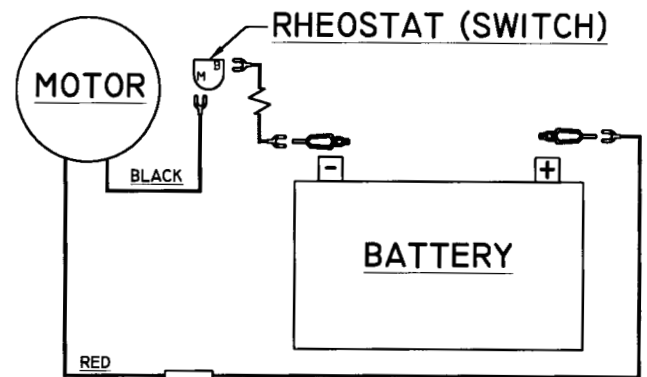

Refer to the electrical schematic above. Strip approximately 1/2" of insulation from the ends of the wires and crimp on the terminals as shown. For best results, solder the connections using electrical grade solder. Attach the wires to the rheostat switch and battery as shown.

NOTE: Always disconnect negative (-) cable first and connect it last.

⚠ CAUTION! ⚠

Always stop engine before disconnecting or connecting battery cables or servicing battery.

When properly connected, the fan should rotate in a clockwise direction, looking down on the fan. The first position on the rheostat switch is full speed, which will be used for most seeding applications. The second position is variable speed, which can be used to reduce the spread width.

The fan motor is for use on 12 volt electrical systems. The motor will draw approximately 3 amps full load. Some vehicle manufactures offer electrical access plug assemblies as a convenience for attaching auxiliary electrical equipment. (Honda consent assemble D.C. #31650-958-681).

To prevent polarity problems, run both wires to the battery, rather than grounding through the chassis frame.

INSTRUCTIONS (continued)

PRE-OPERATION

- Know your controls and how to stop ATV, engine, or pickup quickly in an emergency. READ THIS MANUAL AND THE ONE PROVIDED WITH YOUR ATV.
- To avoid accident or injury, do not allow anyone to operate this equipment without proper instructions. Any person who operates this equipment must be instructed in and be capable of the safe operation of the ATV, implement and all controls.
- Do not allow children to operate this machine.
- Always wear relatively tight and belted clothing to avoid entanglement in moving parts. Wear sturdy, rough-soled work shoes and protective equipment for eyes, hands, and hearing. Never operate ATV in bare feet, sandals, or sneakers.
- Operate only in daylight or good artificial light.
- Ensure implement is properly mounted, adjusted and in good operating condition.
- Be sure that all safety shielding and safety signs are properly installed and in good condition.

OPERATION

Your ATV Broadcast Seeder-Spreader can be used to broadcast most seed (except those planted in rows) – as well as all granular fertilizers. In winter you can control ice and snow by broadcast spreading granular ice control materials. See Operational Spreading Chart.

The ATV Broadcast Seeder-Spreader does not have an agitator in the seed hopper. Some bearded seeds (such as fescue and brome grass) can bridge over the seed gate opening and cause erratic seed flow which will result in skips and misses in the spread pattern.

The above problem can be helped by mixing the seed with dry sand (50/50 mix – then adjust seed gate accordingly to compensate).

1. Check the register of the control lever with the seed gate (material gate). With the seed gate closed, the control lever indicator should so indicate. If it does not, you can adjust the adjustment button on the control rod.
2. DO NOT FILL HOPPER (especially with fertilizer) and transport over long distances, as it may result in packing, causing poor or erratic discharge.

3. FOR BEST RESULTS use pelletized fertilizer, as it has little tendency to lump and cause little or no dust.
4. Be sure to sift or break up lumps found in some types of granular fertilizer before filling hopper.
5. Do not use on windy days, especially when spreading fine grass seed.
6. Use of herbicides (especially Broadleaf weed killers) is NOT RECOMMENDED as there is a possibility of wind drift or over throw of material
7. For best results, cover area twice over a one-half recommended material usage rate, the second time over to run halfway between first spreading width or in a criss-cross pattern. This method allows the most complete and even coverage as well as to give operator a chance to adjust gate setting to compensate for too thin or too heavy a covering the first time over.
8. The spreader will **not work with rock salt**. It will spread granular calcium chloride if dry and free-flowing.
9. When broadcasting fertilizer, always start vehicle in motion before opening feed gate. (Do not allow vehicle to sit stationary with feed gate open.) If fertilizer is accidentally deposited too heavily in a small area, soak down thoroughly with garden hose or sprinkler to prevent burning.
10. The fan speed may be adjusted by turning the variable speed control.

The amount of seed or fertilizer broadcast depends on the size of the hopper opening and the speed of the vehicle. The table shown in an approximate guide based on a vehicle speed of 4 M.P.H. or 8 M.P.H., so adjust for different speeds.

SPREADING INSTRUCTIONS

1. The opening in the hopper bottom is regulated by the control lever. The size of the opening is determined by the calibrated scale. Place the control lever at the desired setting and adjust the stop bolt.
2. Check rate chart for suggested setting for material type to be spread.

INSTRUCTIONS (continued)

SPREADING INSTRUCTIONS (cont.)



KEEP ALL PERSONS AWAY FROM THE ROTATING SPREADERS FAN! NEVER OPERATE WHEN ANYONE IS WITHIN 50 FEET OF SEEDER/SPREADER.



Do not attempt to use your fingers to clear a jam. Accidental closing of the feed gate could pinch or amputate a finger. Be sure that the electric motor is shut off and the power is disconnected before doing any adjustment or repair.

3. Width of spread depends upon the motor speed and the weight of the material. The heavier the material, the wider the spread. The table shows width of spread at full fan rpm, so the width will vary according to the speed of your motor. The rheostat switch can be used to slow the speed of the fan in order to obtain a narrow spread width.

For accurate spreading, calibrate your ATV to operate at the desired speed. A calibrated speedometer is the best and most accurate. If your vehicle does not have a speedometer or its accuracy is questionable, then you may calibrate in the following manner:

Set out two markers 88 feet apart. Select proper gear and adjust throttle speed to give the following travel time as shown between the markers.

- 1 MPH will travel 88 feet in 60 seconds
- 4 MPH will travel 88 feet in 15 seconds
- 6 MPH will travel 88 feet in 11.2 seconds
- 8 MPH will travel 88 feet in 7.5 seconds

After adjusting throttle setting to give speed as desired, mark throttle position in some convenient manner to indicate selected speed. NOTE: After selecting speed, be sure vehicle engine is running fast enough for generator to properly charge battery. On some vehicles it may be necessary to operate in a lower gear to maintain an adequate engine speed for charging battery.

4. Set seed gate opening stop for material to be used according to the selected ground speed and for once or twice over application (twice over recommended), tighten gate stop securely on calibrated seed plate.

If twice over spread is used as recommended, and area is not too large, it is advisable to put approximately one-half of material in hopper. This will give an approximate check of rate usage and will allow for adjustments after first time over.

5. You are now ready to make a trial run to assure accurate results. Close the gate and put in a pre-determined amount of the material to be spread. Spread this and check the results. Make final adjustments to obtain desired results.

MAINTENANCE

You ATV Broadcast Seeder-Spreader is relatively maintenance free. We do make these suggestions:

1. Hopper – The high density Polyethylene hopper is impervious to acids, alkalis and salt. **There is no rust or corrosion.** We do suggest that you clean the Hopper after use for good housekeeping.
2. Storage – After using Broadcaster, remove from vehicle and clean thoroughly. **DO NOT USE WATER** on Electric Drive Unit as it might harm electric motor. Wipe clean with brush or rag and apply a light amount of oil to opening gate slide to prevent sticking, and to ALL bearings. Do not over-oil. Store broadcast upside down in a dry location.
3. Before using, you should check to make sure that all nuts and bolts and set screws are tight.

Paint any bare metal or rusty spots for longer life.

WARNING!! When washing the seeder, completely cover the motor to protect it from water or corrosive solutions. If the motor is not protected, damage may occur. (A plastic bag tied securely works well.)

OBEY ALL SAFETY WARNINGS!

INSTRUCTIONS (continued)

NOTE:

- ★ Since there is no agitator in the seed hopper, these materials will bridge at narrow seed gate settings and cause erratic seeding rates. If bridging occurs at wider seed gate settings, cleaning the seed or blending with a small dense seed such as clover may help. A mix of dry sand with the seed (50/50 mix) can sometimes solve the problem.

OPERATIONAL SPREADING CHART (Calibrated at 4 MPH ground speed)

Material	Spread Width In Feet	Approx. Pounds Per Acre For Setting As Indicated					
		1/4	3/8	1/2	3/4	1	1-1/2
Alfalfa, Red Clover	30	8	12	16	24	32	48
Barley, Wheat, Rye	35	30	45	60	90	120	180
Sweet or Crimson Clover	30	8	12	16	24	32	48
Kentucky Blue or Bermuda Grass ★	15	7	11	14	21	28	
Lespedeza	30		15	20	30	40	60
Oats ★	35		19	25	37	50	75
Timothy	20	10	15	20	30	40	60
Sudan Grass ★	30		15	20	30	40	60
Fertilizer: Pellet or Granule	38	25	37½	50	75	100	150

The spread width indicated on this chart is possible if spinner is operated 30 inches above the ground. Seeder should be level or tilted forward slightly.

NOTE:

Spread Chart settings are approximate – always make trial run to check actual application rate.

The amount of seed or fertilizer broadcast depends on the size of the hopper opening and the speed of the vehicle. The table shown is an approximate guide based on a forward speed of 4 MPH, so adjust for different speeds. A forward speed of 8 mph will cut above rates by one half. A speed of 6 mph will change rates by 75%.

HELPFUL TROUBLE-SHOOTING TIPS

1. Not feeding even –

- A. Seed gate opening may be set too close for the material being spread. To overcome, set the opening larger and driver faster to obtain same spread rate.
- B. Check material for foreign matter or lumps.

2. Poor spread –

- A. Spreader fan speed too slow (under 520 rpm) will result in a narrow spread.
- B. Bent or broken fan blades.

- C. Set screw loose or missing on fan hub.
- D. Too windy for material being spread.
- E. Operator not spacing spread runs properly for correct overlap.
For best results, cover area twice over at one-half recommended material usage rate, the second time over to run halfway between first spreading width or in a criss-cross pattern. This method allows the most complete and even coverage, as well as to give operator a chance to adjust gate setting to compensate for too thin or too heavy a covering the first time over.

ATVK-400 MOUNTING KIT PARTS LIST

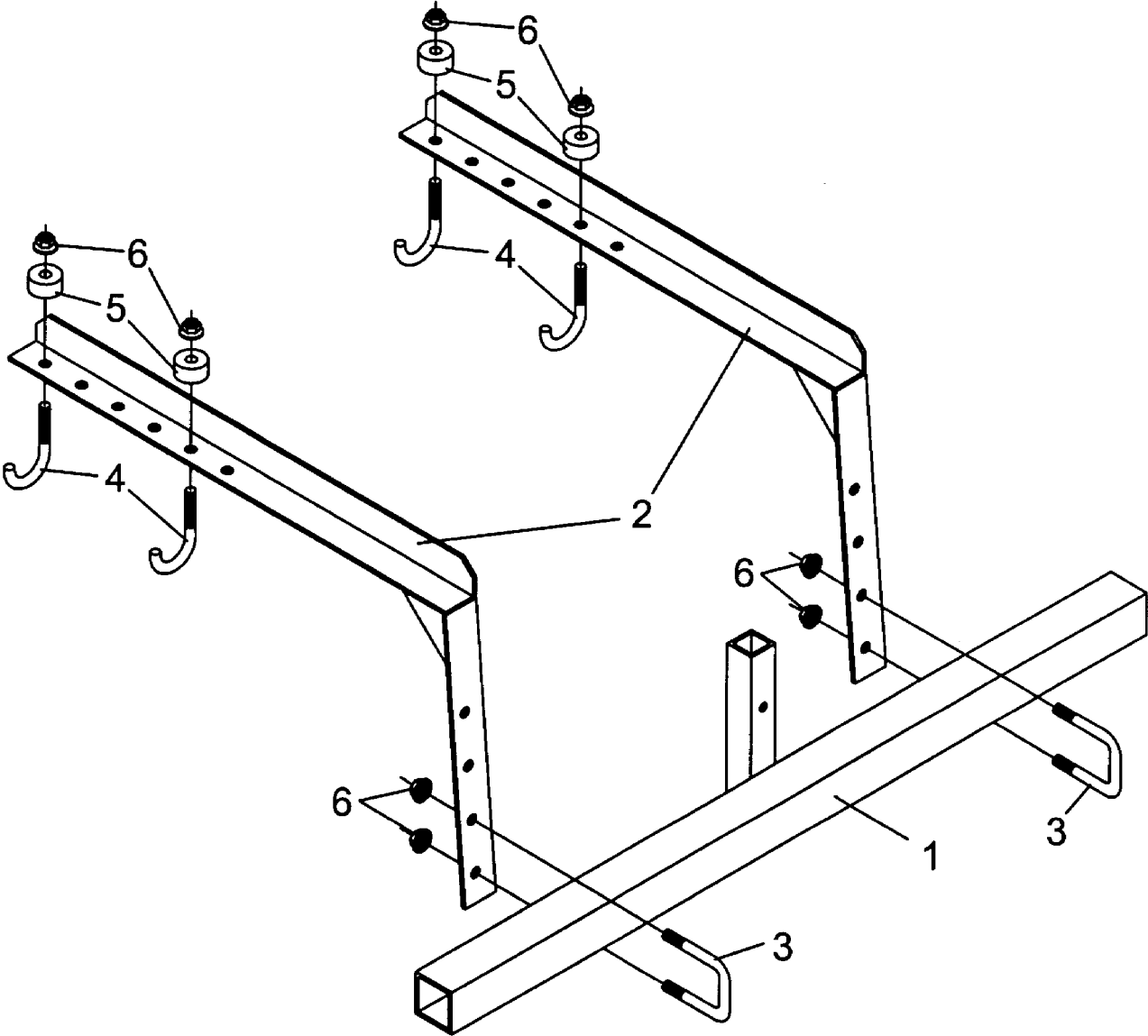

Ref. No.	Part No.	Description	No. Req'd.
1	403426	Seeder Mount Weldment	1
2	403431	Support Leg Weldment	2
3	2503323	U-Bolt 5/16"-18NC 1 1/2" Sq. x 2 1/4"	2
4	2503324	J-Bolt 5/16"-18NC Ø1 1/8" x 2 1/2"	4
5	403428	Spacer	4
6	2500060	Nut 5/16"-18NC Whix Flange Hex	8
N/S	101030	Safety Sign - Warning (Not in Use - Remove)	1

ATV BROADCAST SEEDER-SPREADER PARTS DRAWING

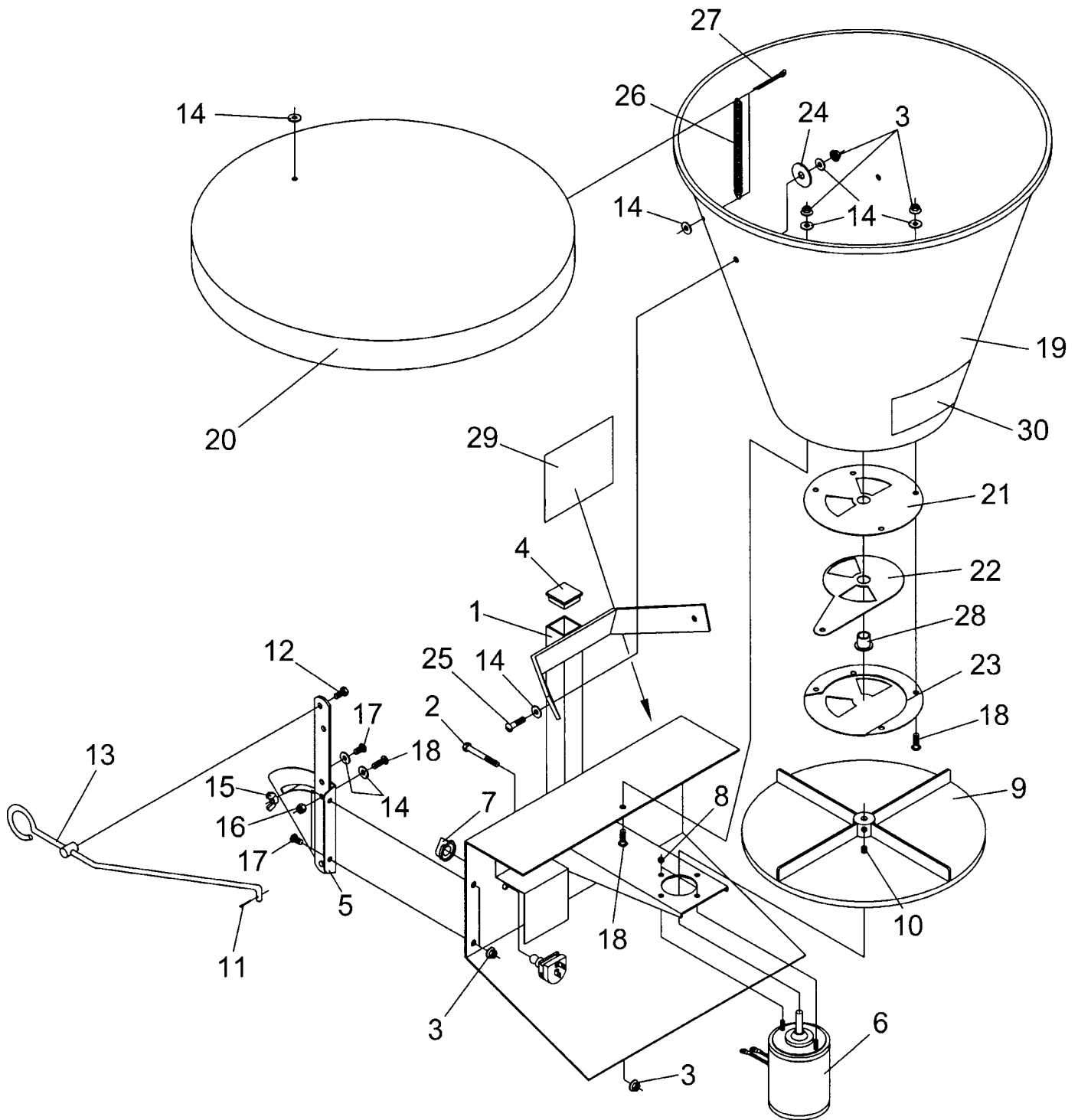

ATV BROADCAST SEEDER-SPREADER PARTS LIST

Ref. No.	Part No.	Description	No. Req'd.
1	402060	Main Frame Weldment (ATVS-100)	1
2	2503104	Bolt 1/4"-20NC x 2" Hex Head	1
3	2500008	Nut 1/4"-20NC Whiz Flange Hex	10
4	2400038	Cap Plug, Plastic 1 1/4"	1
5	480017	Scale Plate & Lever Assembly	1
6	2401026	Motor 12V DC	1
7	2401014	Switch, Rheostat 12 V	1
NS	2401013	Terminal, Spade 14 Ga. Wire	4
NS	2401010	Connector, Butt #14 Wire	1
NS	2401011	Clamp, Battery (Alligator)	2
NS	402024	Wire 14 Ga. x 3 1/2 Ft. Long	1
NS	402025	Wire 14 Ga. x 6 Ft. Long	1
8	2500005	Nut #8-32NC Hex	2
9	403421	Fan, Plastic	1
10	2503042	Set Screw 5/16"-18NC x 5/16"	2
11	2504010	Pin, Cotter 3/32" x 1/2"	1
12	2503027	Bolt 1/4"-28NF x 1/2" Hex Head	1
13	402021	Control Rod & Pin Assembly	1
14	2501006	Washer 1/4" Flat	13
15	2500007	Nut 1/4"-20NC Wing	1
16	2500006	Nut 1/4"-20NC Hex Nylock	1
17	2503008	Bolt 1/4"-20NC x 1/2" Round Head	3
18	2503014	Bolt 1/4"-20NC x 3/4" Round Head	6
	402026	Hopper Assembly (Includes Items #19 thru #28; also includes [7] #3's, [11] #14's, & [5] #18's)	1
19	2401004	Hopper (1 Bushel) w/Lid	
20	2401005	Lid, Hopper (1 Bushel) Only	1
21	402050	Seed Plate Support	1
22	3450008	Middle Plate	1
23	420510	Lower Plate	1
24	2501017	Washer 3/8" Fender	2
25	2503009	Bolt 1/4"-20NC x 1" Round Head	2
26	403305	Spring, Extension	1
27	2504015	Pin, Cotter 1/8" x 1 1/2"	2
28	2505003	Bearing, Flanged Bronze 1/2" ID	1
29	101011	Spread Chart Decal	1
30	101022	Safety Sign - Warning (Spinner)	1



SAFETY PRECAUTIONS

MOST ACCIDENTS OCCUR BECAUSE OF NEGLIGENCE OR CARELESSNESS. AVOID NEEDLESS ACCIDENTS BY FOLLOWING ALL OF THE SAFETY PRECAUTIONS LISTED BELOW.

1. Read instruction manual and make sure all operators are knowledgeable on correct operation of equipment.
2. Machinery should be operated only by those who are responsible and are authorized to do so.
3. Stop the engine, lock the brakes, and remove the ignition key before dismounting from the vehicle.
4. Loose fitting clothing should not be worn, to avoid catching on various parts.
5. Only a qualified operator should be permitted on ATV when in operation; no riders allowed.
6. When spreading seed or fertilizer, it is recommended to use safety goggles.
7. Equipment is not designed for road speeds above 20 mph.
8. Operate the ATV only while seated in the driver's seat.
9. Reduce speed when transporting mounted implements to avoid bouncing and momentary loss of steering control.
10. Reduce speed on hillsides or curves so there is no danger of tipping.
11. Avoid driving too close to the edge of ditches or creeks.
12. Keep alert and watch the front as well as the rear when working with the seeder-spreader.
13. Never operate spreader when anyone is within 50 feet of equipment.
14. Always observe your ATV manufacturer's safety precautions in addition to the above safety precautions.

NOTE: Warranty is void if seeder unit is not used with a Worksaver mounting kit.

OWNER'S/ OPERATOR'S MANUAL

**MODEL NO.
ATVK-400**

**WHEN ORDERING
REPAIR PARTS, ALWAYS
GIVE THE FOLLOWING
INFORMATION:**

1. PART NUMBER
2. PART DESCRIPTION
3. MODEL NUMBER
4. NAME OF ITEM

OCTOBER 2007

Please work, drive, play and live each day with care and concern for your safety and that of your family and fellow citizens.

**MAKE EVERY DAY
A HOLIDAY FROM ACCIDENTS**

ATV Broadcast Seeder - Spreader

WORKSAVER LIMITED WARRANTY

Worksaver warrants its implements, parts and accessories to be free from defects in materials and workmanship for a period of six (6) months from date of purchase. Upon written approval, **Worksaver** will repair or exchange without charge any part, which upon examination by **Worksaver** or its authorized agent, shall disclose to be defective.

This does not apply to (1) parts that have worn out in normal use, (2) parts broken because of improper assembly or operation by the customer, (3) parts accidentally damaged, (4) failure of parts traceable to improper care, (5) parts failing through use of implement for purposes other than those for which it was designed.

The obligations assumed by **Worksaver** and the limitations expressed herein are in lieu of all other warranties expressed or implied.

WORKSAVER, INC.

P.O. BOX 100 LITCHFIELD, IL 62056-0100 (217) 324-5973
WEB: <http://www.worksaver.com> E-MAIL: sales@worksaver.com